

## Table – Parts List

Index No.	Part No.	Description	Size	Qty
1	TS-1521011	Socket Set Screw	M4x4	3
2	JWS35X-102	Insert Ring (Small)		1
3	TS-2285121	Flat Head Machine Screw	M5x12	3
4	JWS35X-104	Insert Ring (Large)		1
5	JWS35X-105	Table		1
6	PM2700-105	Starting Pin		1
7	1791789	Miter Gauge Assembly (Index # 7-1 thru # 7-22)		1
7-1	PM2000-340	Handle		1
7-2	TS-0680031	Flat Washer	5/16"	1
7-3	PM2000-342	Fence		1
7-4	PM2000-343	Socket Set Screw	M8x6	2
7-5	PM2000-325	Miter Bar		1
7-6	PM2000-326	Guide Washer		1
7-7	PM2000-327	Flat Head Machine Screw	M6x9	1
7-8	TS-0050051	Hex Cap Screw	1/4"-20x1"	2
7-9	PM2000-323	Miter Gauge Body		1
7-10	PM2000-324	Pin		1
7-11	PM2000-337	Gear Shaft		1
7-12	PM2000-336	Spring		1
7-13	PM2000-338	Scale		1
7-14	PM2000-333	Locking Handle		2
7-15	TS-0810012	Round Head Screw	#10-24x1/4"	1
7-16	TS-1550031	Flat Washer	M5	1
7-17	PM2000-335	Pointer		1
7-18	PM2000-330	Support Base		1
7-19	PM2000-329	Socket Head Cap Screw	M5x8	2
7-20	TS-1521011	Socket Set Screw	M4x4	1
7-21	PM2000-331	Knob		1
7-22	PM2000-339	Rivet		2

# Table – Assembly Drawing

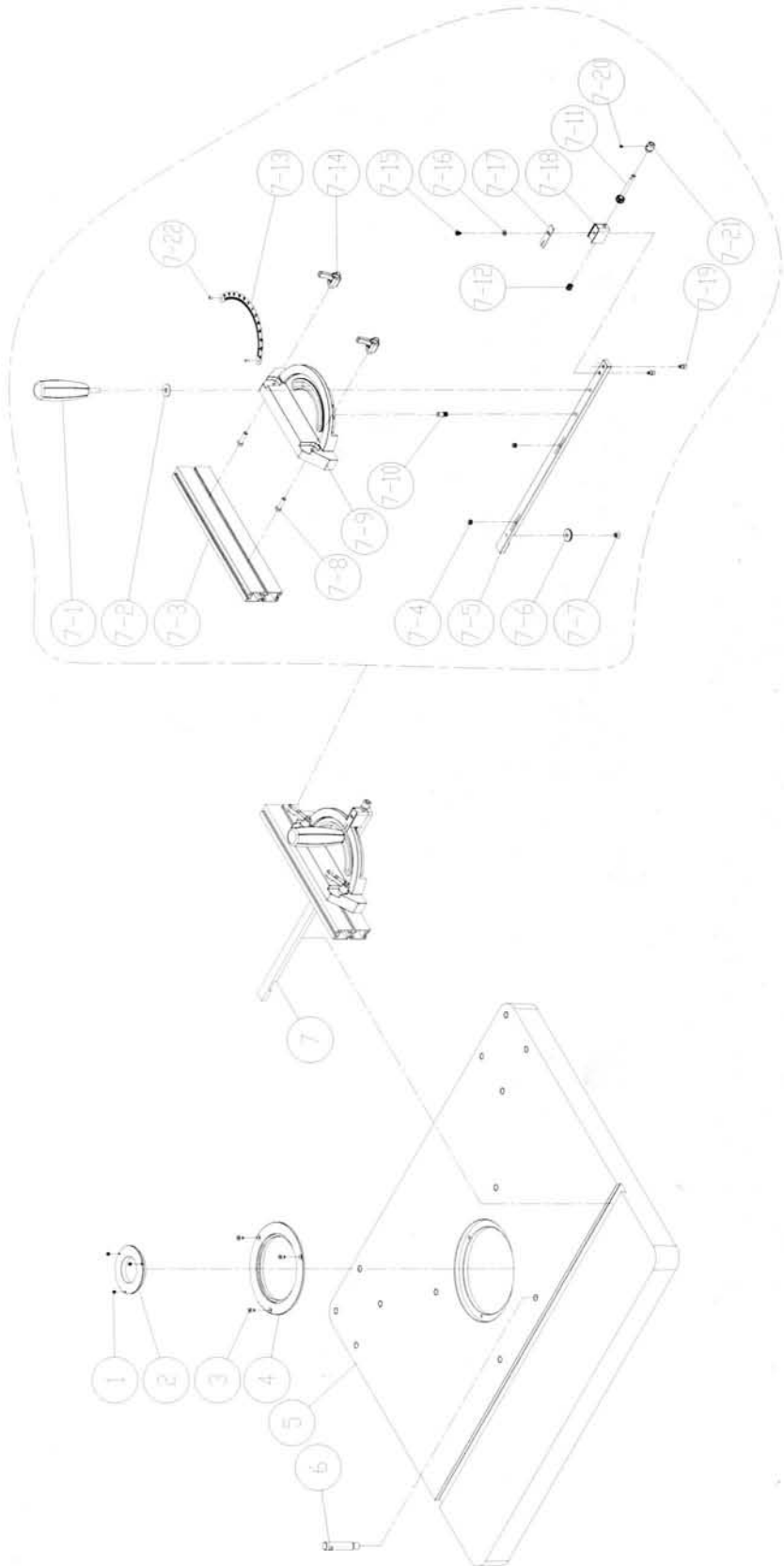

## Fence – Parts List

Index No.	Part No.	Description	Size	Qty
1	JWS35X-201	Knob		4
2	PM2700-237	Feather Board		2
3	PM2700-234	Bracket		2
4	TS-1550061	Flat Washer	M8	4
5	PM2700-232	Lock Handle		4
6	PM2700-235	Carriage Bolt	M5x30	4
7	PM2700-231	End Cap		2
8	JWS35X-208	Fence		2
9	JWS35X-209	Slide		2
10	JWS35X-210	Left Fence Plate		1
11	JWS35X-211	Plastic Flat Washer		2
12	JWS35X-212	Leader Screw		2
13	TS-1523021	Socket Set Screw	M6x8	5
14	JWS35X-214	Knob		5
15	TS-1540041	Hex Nut	M6	1
16	JWS35X-216	Socket Set Screw	M6x30	1
17	TS-1504031	Socket Head Cap Screw	M8x16	1
18	TS-1523041	Socket Set Screw	M6x12	4
19	JWS35X-219	Shaft		1
20	JWS35X-220	Adjustment Leader		1
21	TS-1540061	Hex Nut	M8	1
22	JWS35X-222	Socket Set Screw	M8x30	1
23	JWS35X-223	Scale		1
24	TS-1533032	Pan Head Machine Screw	M5x10	1
25	JWS35X-225	Bracket		1
26	TS-1550031	Flat Washer	M5	4
27	TS-1533052	Pan Head Machine Screw	M5x16	2
28	JWS35X-228	Fixing Plate		1
29	TS-2284082	Pan Head Machine Screw	M4x8	4
30	JWS35X-230	Knob		5
31	PM2700-203	Cutter Guard		1
32	JWS35X-232	Safety Guard Holder		1
33	TS-1550041	Flat Washer	M6	2
34	JWS35X-234	Shaft		2
35	TS-155009	Flat Washer	M14	2
36	JWS35X-236	Dust Chute		1
37	JWS35X-237	Fence Body		1
38	PM2700-205	Flat Washer	M13	4
39	JWS35X-239	Spring		2
40	JWS35X-240	Lock Nut	1/2"-12	2
41	PM2700-236	Carriage Bolt	M5x16	4
42	JWS35X-242	Wave Washer		1
43	JWS35X-243	Flat Washer		1
	JWS35X-FA	Fence – Complete Assembly (Index #1 - #43)		1

# Fence – Assembly Drawing

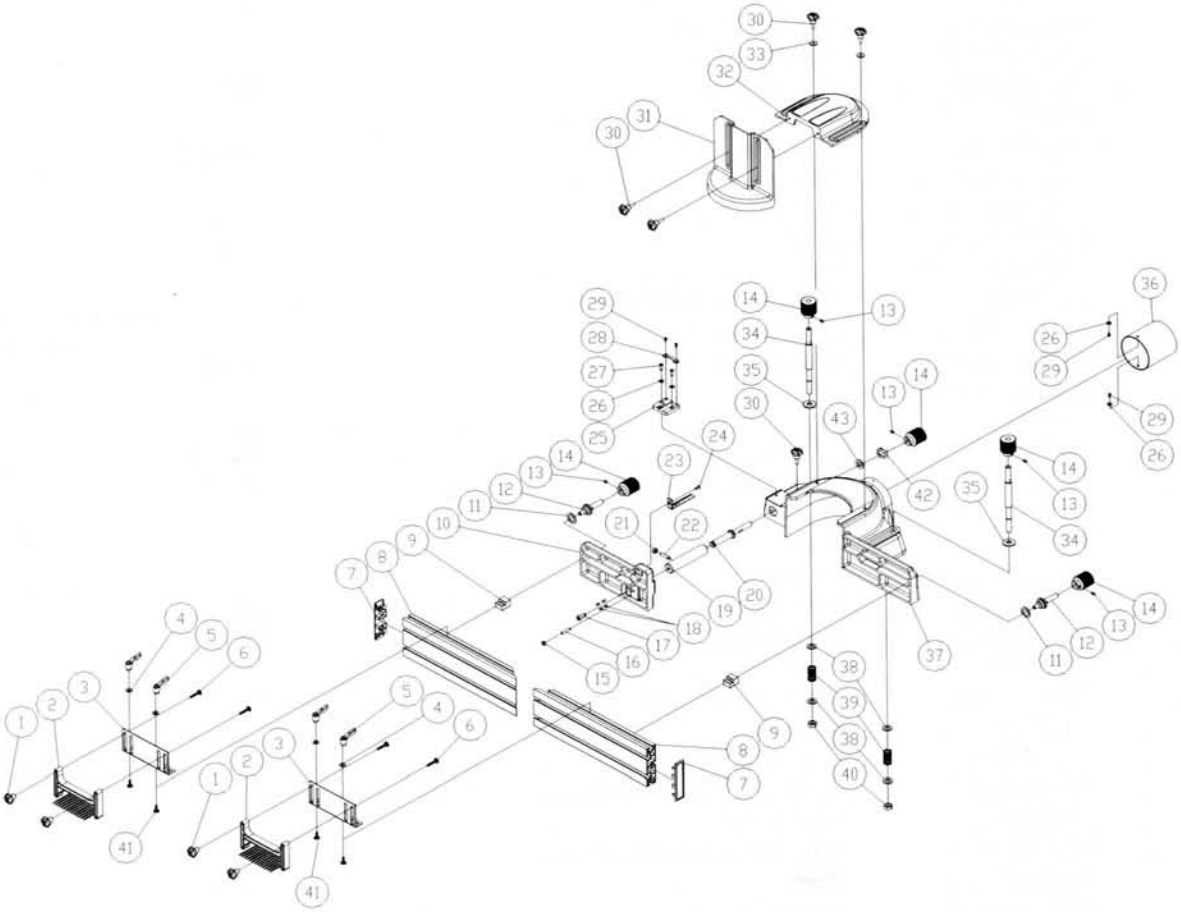

## Frame and Motor – Parts List

Index No.	Part No.	Description	Size	Qty
1	PM2700-305A	Spindle Nut	M40x2.5p	1
2	PM2700-306	Retaining Ring	STW-40	1
3	TS-2246202	Button Head Socket Screw	M6x20	4
4	TS-2361061	Lock Washer	M6	4
5	PM2700-308N	Shaft Top Bearing Cover		1
6	BB-6008VV	Bearing	6008VV	2
7	JWS35X-307N	Spindle Holder		1
8	JWS35X-308	Key	8x7x72	1
9	PM2700-312N	Quill		1
	JWS35X-QAN	Quill Assembly (Index #2 ~ #15; #61, #62)		1
11	JWS35X-311	Bushing		1
12	JWS35X-312	Spindle Pulley		1
13	JWS35X-313	Flat Washer	M30	1
14	JWS35X-314	Locking Washer	M30	1
15	JWS35X-315	Locking Nut	M30-1.5P	1
16	JWS35X-316	Draw Bar		1
17	PM2700-318	Spindle Housing		1
18	TS-1523021	Socket Set Screw	M6x8	1
19	JWS35X-319	Pointer		1
20	TS-1550041	Flat Washer	M6	2
21	TS-1503031	Socket Head Cap Screw	M6x12	6
22	TS-1551061	Lock Washer	M8	5
23	TS-1504061	Socket Head Cap Screw	M8x30	1
24	PM2700-348	Belt Tension Handle		1
25	TS-2361061	Lock Washer	M6	4
26	TS-1540071	Hex Nut	M10	1
27	PM2700-346	Hex Bushing		1
28	PM2700-338	Pin	Ø3 x 20	1
29	PM2700-339	Rod		1
30	PM2700-340	Spring		1
31	PM2700-337	Connector		1
32	TS-2361101	Lock Washer	M10	1
33	TS-2239551	Socket Head Cap Screw	M10x55	1
34	TS-1523021	Socket Set Screw	M6x8	1
35	PM2700-341	Knob		1
36	PM2700-342	Retaining Ring	STW-15	2
37	PM2700-343	Flat Washer	M15	2
38	PM2700-344	Connector		1
39	PM2700-345	Shaft		1
40	PM2700-334	Retaining Ring	STW-20	1
41	TS-1550111	Flat Washer	M20	1
42	PM2700-332	Adjustment Bolt		1
43	JWS35X-343	Motor Bracket		1
44	PM2700-330	Shaft		1
45	PM2700-314	Flat Washer	M25	1
46	PM2700-328	Retaining Ring	STW-25	1
47	TS-1550061	Flat Washer	M8	4
48	TS-1490031	Hex Cap Screw	M8x20	4
49	JWS35X-349	Key	6x6x55	1
50	JWS35X-350	Special Flat Washer	M8	1
51	TS-1551061	Lock Washer	M8	1
52	TS-1504041	Socket Head Cap Screw	M8x20	1
53	JWS35X-353	Belt (3HP / 5HP)	240J	1
54	TS-1501021	Socket Head Cap Screw	M4x8	3
55	TS-1551021	Lock Washer	M4	3

# Frame and Motor – Parts List

Index No.	Part No.	Description	Size	Qty
56	JWS35X-356	Cover		1
57	JWS35X-357	Motor Pulley		1
58	JWS35X-358	Motor	3HP, 230V, 1Ph	1
	JWS35X-358A	Motor	5HP, 230V, 1Ph	1
	JWS35X-358B	Motor	5HP, 230/460V, 3Ph	1
	JWS35X-358CS	Centrifugal Switch (not shown)		1
	JWS35X-358FC	Fan Cover (not shown)		1
	JWS35X-358MF	Motor Fan (not shown)		1
	JWS35X-358SC	Starting Capacitor (not shown) - for 3HP, 1Ph Motor		1
	JWS35X-358RC	Running Capacitor (not shown) - for 3HP, 1Ph Motor		1
	JWS35X-358ASC	Starting Capacitor (not shown) - for 5HP, 1Ph Motor		1
	JWS35X-358ARC	Running Capacitor (not shown) - for 5HP, 1Ph Motor		1
59	JWS35X-359	Strain Relief Bushing	PGA16-14B	1
60	PM2700-349	Spindle Nut Wrench		1
61	PM2700-350	Upper Bushing		1
62	PM2700-351	Wave Washer		1

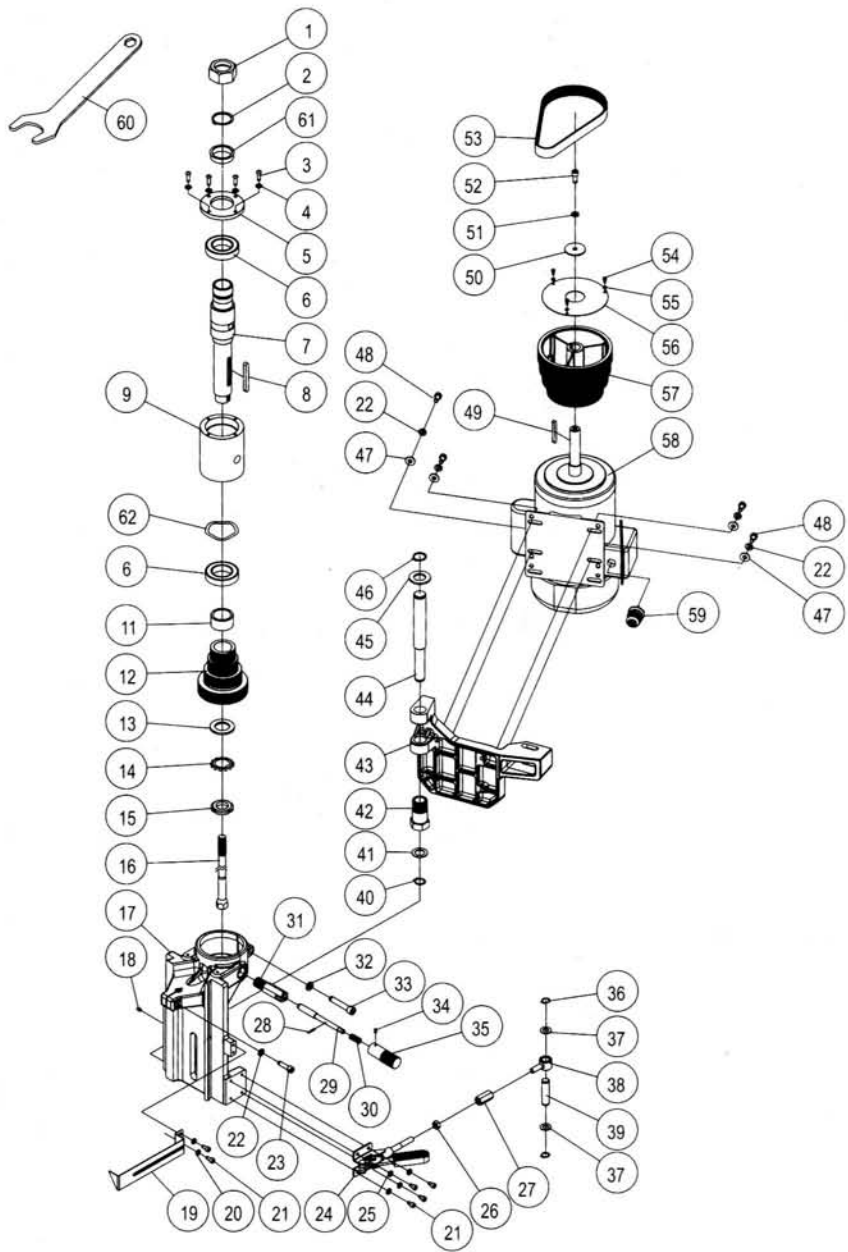



## Cabinet and Base – Parts List

Index No.	Part No.	Description	Size	Qty
1	TS-1533032	Pan Head Machine Screw	M5x10	2
2	JWS35X-402	Cover		1
3	TS-1550071	Flat Washer	M10	4
4	TS-2361101	Lock Washer	M10	4
5	TS-1491031	Hex Cap Screw	M10x25	4
6	JWS35X-406	Strain Relief		5
7	PM2700-113	Tapping Screw	M5-2.12P x 25	2
8	PM2700-114	Magnetic Switch	3HP, 230V, 1Ph	1
	PM2700-114A	Magnetic Switch	5HP, 230V, 1Ph	1
	PM2700-114B	Magnetic Switch	5HP, 230V, 3Ph	1
	PM2700-114C	Magnetic Switch	5HP, 460V, 3Ph	1
8-1	PM2000-298	Safety Key for Magnetic Switch		1
9	JWS35X-409	Switch Cover		1
10	PM2700-448	Forward/Reverse Switch	3HP/1Ph	1
	PM2700-448A	Forward/Reverse Switch	5HP/1Ph	1
	PM2700-448B	Forward/Reverse Switch	5HP/3Ph	1
11	JWS35X-411	Stripe		1
12	JWS35X-412	JET Logo		1
13	PM2700-416	Bumper		2
14	JWS35X-414	Cabinet		1
15	TS-1540041	Hex Nut	M6	4
16	TS-2361061	Lock Washer	M6	4
17	PM2700-433	Window		1
18	JWS35X-418	Door		1
19	TS-1534042	Pan Head Machine Screw	M6x12	4
20	PM2700-436	Latch		1
21	JWS35X-421	Motor Cable (3HP/1Ph) (5HP/3Ph)	14AWG x 4C x 1300mm	1
	JWS35X-421A	Motor Cable (5HP/1Ph)	12AWG x 5C x 1300mm	1
22	JWS35X-422	Switch to Switch Cable (3HP/1Ph)	14AWG x 5C x 480mm	1
	JWS35X-422A	Switch to Switch Cable (5HP/1Ph)	12AWG x 5C x 480mm	1
	JWS35X-422B	Switch to Switch Cable (5HP/3Ph)	14AWG x 5C x 480mm	1
23	JWS35X-423	Power Cable (3HP/1Ph)	14AWG x 3C x 3300mm	1
	JWS35X-423A	Power Cable (5HP/1Ph)	12AWG x 3C x 3300mm	1
	JWS35X-423B	Power Cable (5HP/3Ph)	14AWG x 4C x 3300mm	1
24	JWS35X-424	Scale		1
25	JWS35X-425	Warning Label		1

# Cabinet and Base – Assembly Drawing

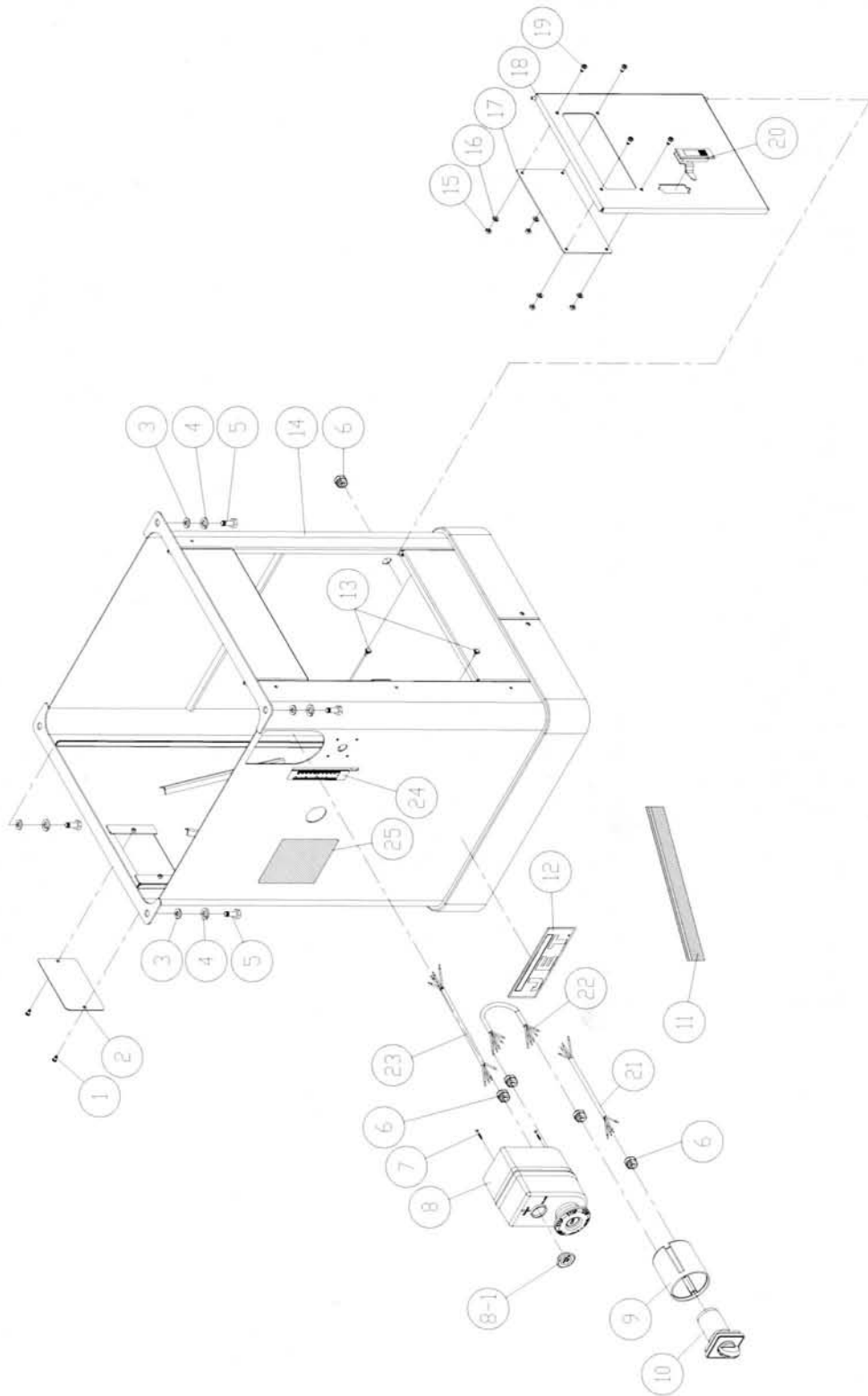



# Elevator – Parts and Assembly

Index No.	Part No.	Description	Size	Qty
1	JWS35X-501	Lead Screw		1
2	JWS35X-502	Key	5x5x12	2
3	PM2700-342	Retaining Ring	STW-15	1
4	PM2700-503	Thrust Bearing	51202	2
5	PM2700-504	Hex Nut	M20-1.5P	4
6	PM2700-505	Adjusting Bolt		4
7	TS-2361121	Lock Washer	M12	4
8	TS-1506141	Socket Head Cap Screw	M12x90	4
9	PM2700-512	Housing		1
10	TS-1522011	Socket Set Screw	M5x6	4
11	TS-0270021	Socket Set Screw	5/16"-18x5/16"	4
12	PM2700-521	Key		1
13	PM2700-522	Key	5x5x20	1
14	TS-1523021	Socket Set Screw	M6x8	1
15	JWS35X-515	Hand Wheel		1
16	JWS35X-516	Knob		1
17	JWS35X-517	Handle		1
18	PM2700-519	Fixing Ring		2
19	PM2700-520	Washer	M19	2
20	PM2700-523	Shaft		1
21	PM2700-513	Worm Gear (Right rotation)		1
22	JWS35X-522	Worm Gear (Left rotation)		1
23	TS-1550071	Flat Washer	M10	1
24	TS-2342102	Nylon Insert Lock Nut	M10-1.25P	1
25	TS-1540061	Hex Nut	M8	4
26	PM2700-508	Socket Set Screw	M8x30	4
27	TS-1505021	Socket Head Cap Screw	M10x20	1
28	PM2700-450	Plug		1
29	PM2700-510	Gib		1

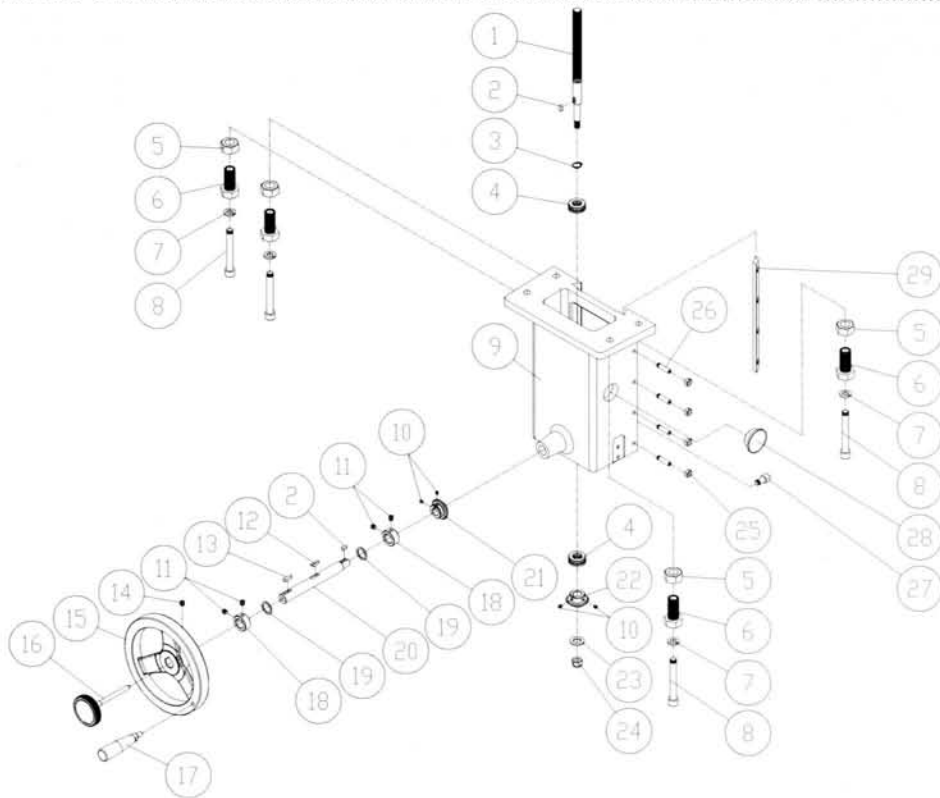

## Spindle Assembly – Parts

Index No.	Part No.	Description	Size	Qty
1	TS-1505031	Socket Head Cap Screw	M10x25	4
2	PM2700-708	Special Washer		1
3	PM2700-709	Keyed Collar		1
4	PM2700-710	Collar	I.D. 3/4" x 1/2"T	4
5	PM2700-711	Collar	I.D. 3/4" x 3/4"T	2
6	PM2700-712	Spindle	3/4"	1
	708317	Spindle w/Nut Assembly (#1 - #6, #32)	3/4"	1
7	PM2700-702	Pin		2
8	PM2700-703	Special Washer		1
9	PM2700-704	Keyed Collar		1
10	PM2700-705	Collar	I.D. 1-1/4" x 3/4"T	2
11	PM2700-706	Collar	I.D. 1-1/4" x 1/2"T	4
12	JWS35X-612	Spindle	1-1/4"	1
	708328	Spindle w/Nut Assembly (#1, #7 - #12, #32)	1-1/4"	1
13	PM2700-713	Special Washer		1
14	PM2700-714	Keyed Collar		1
15	PM2700-715	Collar	I.D. 1" x 3/4"T	4
16	PM2700-716	Collar	I.D. 1" x 1/2"T	2
17	JWS35X-617	Spindle	1"	1
	708314	Spindle w/Nut Assembly (#1, #13 - #17, #32)	1"	1
18	TS-1504051	Socket Head Cap Screw	M8x25	1
19	PM2700-719	Special Washer		1
20	PM2700-720	Keyed Collar		1
21	PM2700-721	Collar	I.D. 1/2" x 3/4"T	2
22	PM2700-722	Collar	I.D. 1/2" x 1/2"T	2
23	PM2700-723	Spindle	1/2"	1
	708381	Spindle w/Nut Assembly (#18 - #23, #32)	1/2"	1
24	PM2700-724	Pin		2
25	PM2700-725	Special Washer		1
26	PM2700-726	Collar	M30 x 20mmT	2
27	PM2700-727	Collar	M30 x 8mmT	2
28	PM2700-728	Collar	M30 x 10mmT	2
29	PM2700-729	Spindle	M30	1
	708372	Spindle w/Nut Assembly (#1, #24 - #29, #32)	30mm	1
30	708373	Collet	1/4"	1
31	708374	Collet	1/2"	1
32	PM2700-305A	Spindle Nut	M40x2.5p	5

# Spindle Assembly Drawing

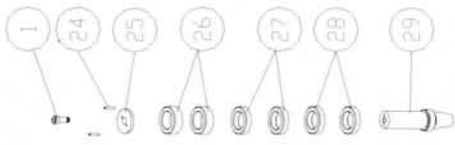

30mm Spindle

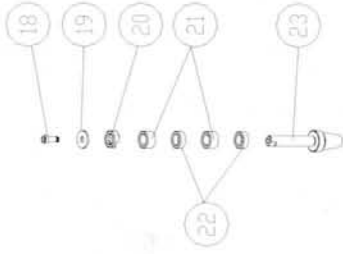

1/2" Spindle

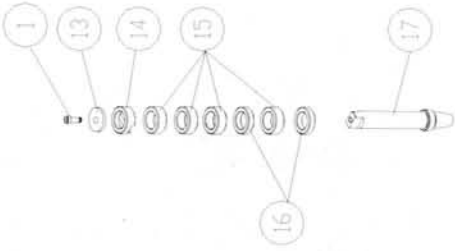

1" Spindle

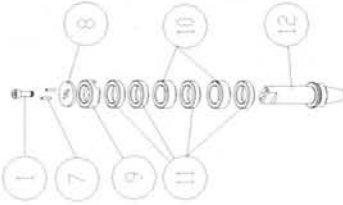

1-1/4" Spindle

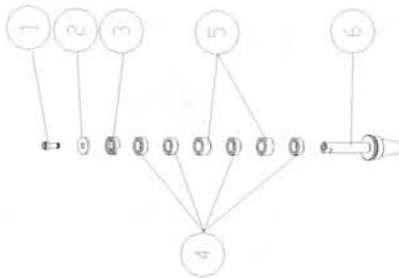

3/4" Spindle



1/2" Router Collet



1/4" Router Collet

# Wiring Diagrams 3HP/5HP, 230V, 1Phase

3HP, 230V, 1Ph

5HP, 230V, 1Ph



## Magnetic Switch

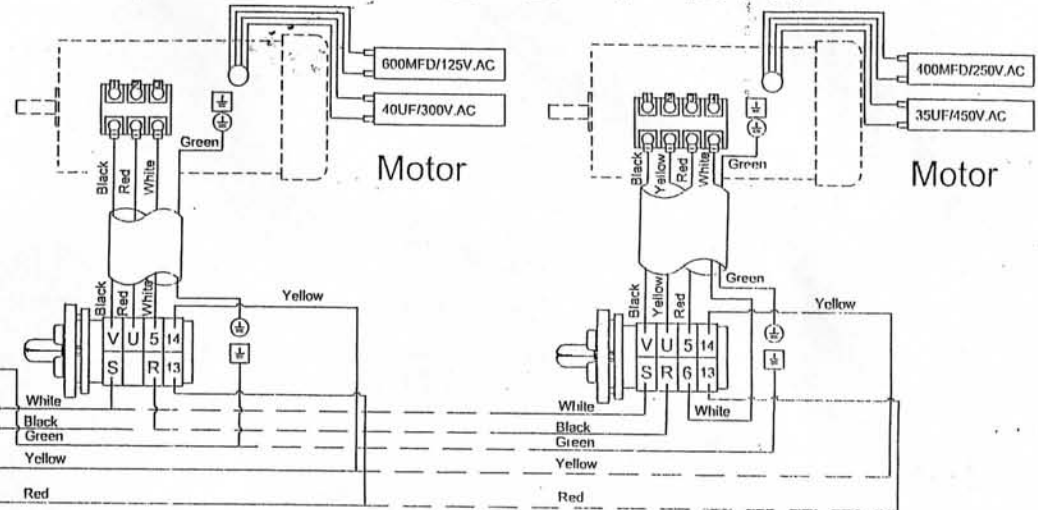
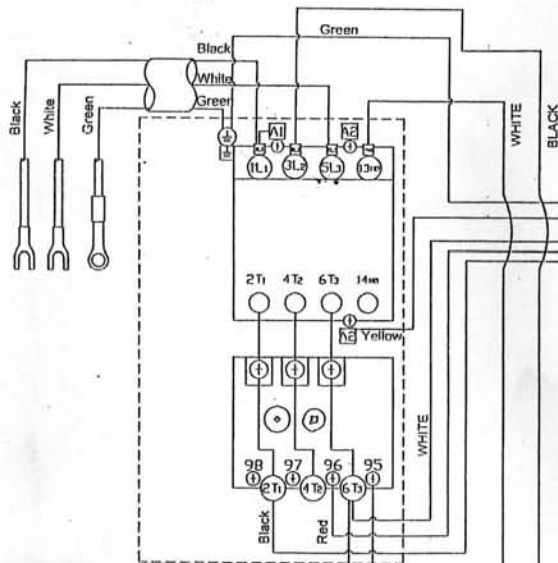

## Electrical Board

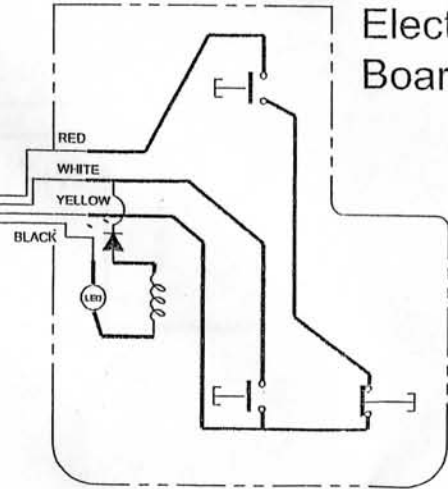

5HP,230V,3Ph

5HP,460V,3Ph

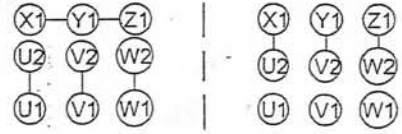

# Electrical Schematic - Three Phase

5HP,230/460 V,3Ph

